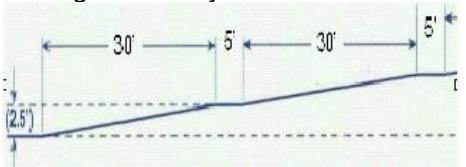

# ADA CHECKLIST

Revised July 8, 2024

Job No. \_\_\_\_\_ Route \_\_\_\_\_ County \_\_\_\_\_ Location \_\_\_\_\_

<b>Pedestrian Access Route (PROWAG R204)</b>				
<b>Figures/Examples</b>	<b>Requirements <sup>1</sup></b>	<b>YES</b>	<b>NO</b>	<b>NA</b>
<p><b>Sidewalk Width</b></p> 	<ul style="list-style-type: none"> <li>• The minimum continuous and unobstructed clear width of a pedestrian access route shall be 4.0 feet, exclusive of the width of the curb.</li> <li>• The continuous clear width of pedestrian access routes for medians and pedestrian refuge islands must be 5 feet minimum in order to allow for passing space.</li> <li>• MoDOT Sidewalks shall be 5 feet wide minimum. <sup>2</sup></li> <li>• MoDOT Sidewalks located within 2 feet of the back of curb are to be constructed 6 feet wide minimum and constructed adjacent to the back of the curb. <sup>2</sup></li> <li>• Exception: an unaltered, existing sidewalk shall be 3 feet wide minimum and shall provide 5 foot x 5 foot passing spaces at intervals of 200 feet maximum. <sup>2</sup></li> <li>• Detectable warning surfaces shall be provided, where a curb ramp, landing, or blended transition connects to a street. Where commercial driveways are provided with traffic control devices or otherwise are permitted to operate like public streets, detectable warnings should be provided at the junction between the pedestrian route and the street.</li> <li>• Gratings, access covers, and other appurtenances shall not be located on curb ramps, landings, blended transitions, and gutters within the pedestrian access route.</li> <li>• Grade breaks shall not be permitted on the surface of curb ramps, blended transitions, landings, and gutter areas within the pedestrian access route. Surface slopes that meet at grade breaks shall be flush.</li> </ul>			
<p><b>Passing Spaces</b></p>	<ul style="list-style-type: none"> <li>• Walkways in pedestrian access routes that are less than 5 feet in clear width shall provide passing spaces at intervals of 200 feet maximum.</li> <li>• Pedestrian access routes at passing spaces shall be 5 feet wide for a distance of 5 feet.</li> </ul>			
<p><b>Sidewalk Running Slope</b> The grade that is parallel to the direction of travel, expressed as a ratio of rise to run or as a percent.</p>	<ul style="list-style-type: none"> <li>• The running slope of a pedestrian access route shall be 5 percent maximum.</li> <li>• <b><u>Roadway Grade Exception:</u></b> Where pedestrian access routes are contained within a street or highway right-of-way, the grade of the pedestrian access route is permitted to equal the general grade established for the adjacent street or highway.</li> <li>• Running Slopes shall be measured using a calibrated 2 foot long digital level.</li> </ul>			

Figures/Examples	Requirements <sup>1</sup>	YES	NO	NA
<p><b>Sidewalk Cross Slope</b>  The grade that is perpendicular to the direction of accessible pedestrian travel, measured perpendicular to the curb line or edge of the street or highway, or measured perpendicular to the running grade.</p>	<ul style="list-style-type: none"> <li>• The cross slope of the walkway of a pedestrian access route shall be 2 percent maximum. (Roadway Grade Exception may be considered)</li> <li>• 2010 ADA/ABA allows for cross slopes of up to ¼ inch per foot (2.08 percent).</li> <li>• In either case, a cross slope measurement of 2.1 percent or greater is not ADA compliant.</li> <li>• Cross Slopes shall be measured using a calibrated 2 foot long digital level.</li> </ul>			
<p><b>Sidewalk Ramps</b></p> <p>For example, a sidewalk ramp segment with the maximum allowed running slope of 8.33% would require a landing after every 30' of run.</p>  <p>The diagram illustrates a sidewalk ramp segment. It starts with a 30-foot horizontal run that rises 2.5 inches. This is followed by a 5-foot horizontal landing. The second 30-foot horizontal run also rises 2.5 inches. The total length of the segment is 65 feet, with a total rise of 5 inches. The maximum allowed running slope is 8.33%.</p>	<ul style="list-style-type: none"> <li>• A sidewalk segment (not contained within a street or highway border) with a running grade in excess of 5 percent but less than 8.33 percent is by definition a sidewalk ramp.</li> <li>• Sidewalk Ramps shall have landings at the top and the bottom of each ramp run. <ul style="list-style-type: none"> <li>- The landing clear width shall be at least as wide as the widest ramp run leading to the landing.</li> <li>- The landing clear length shall be 5.0 feet long minimum.</li> <li>- Sidewalk Ramps that change direction between runs at landings shall have a clear landing 5.0 feet minimum by 5.0 feet minimum.</li> <li>- Landing slopes shall be 2 percent maximum.</li> <li>- Changes in level at grade breaks shall be flush.</li> </ul> </li> <li>• Cross slope of ramp runs shall be 2 percent maximum.</li> <li>• The rise for any ramp run shall be 30 inches maximum.</li> <li>• Sidewalk Ramp runs with a rise greater than 6 inches shall have handrails.</li> <li>• Handrails shall be provided on both sides of stairs and sidewalk ramps.</li> <li>• Edge protection shall be provided on each side of sidewalk ramp runs.</li> <li>• Detectable warning surfaces shall be provided, where a curb ramp, landing, or blended transition connects to a street.</li> <li>• Gratings, access covers, and other appurtenances shall not be located on ramps, landings, blended transitions, and gutters within the pedestrian access route.</li> <li>• Grade breaks shall not be permitted on the surface of ramps, blended transitions, landings, and gutter areas within the pedestrian access route. Surface slopes that meet at grade breaks shall be flush.</li> </ul>			

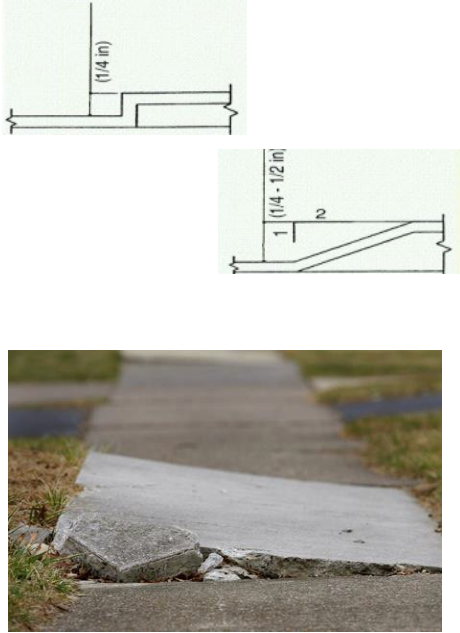
Figures/Examples	Requirements <sup>1</sup>	YES	NO	NA
<p data-bbox="92 136 352 168">Vertical Alignment</p>	<ul data-bbox="583 136 1709 574" style="list-style-type: none"> <li>• Vertical alignment shall be planar within curb ramp runs, blended transitions, landings, and gutter areas within the pedestrian access route, and within clear spaces required for accessible pedestrian signals, street furniture, and operable parts.</li> <li>• Grade breaks shall not be permitted on the surface of curb ramps, blended transitions, landings, and gutter areas within the pedestrian access route.</li> <li>• Grade breaks shall be flush.</li> <li>• Running Slopes and Cross Slopes shall be measured using a calibrated 2 foot long digital level.</li> <li>• Where the pedestrian access route crosses rail tracks at grade, the surface of the pedestrian access route shall be level and flush with the top of the rail at the outer edges of the rail. The surface between the rails shall be aligned with the top of the rail.</li> </ul>			
<p data-bbox="92 586 340 618">Changes in Level</p> 	<ul data-bbox="583 586 1717 824" style="list-style-type: none"> <li>• Changes in level at grade breaks shall be flush.</li> <li>• Changes in level of ¼ inch high maximum shall be permitted to be vertical.</li> <li>• Changes in level between ¼ inch high maximum and ½ inch high maximum shall be beveled with a slope not steeper than 1v:2h.</li> <li>• The bevel shall be applied across the entire level change.</li> <li>• Changes in level greater than ½ inch high shall be ramp grade or flatter, a slope of 8.33 percent or less.</li> </ul>			

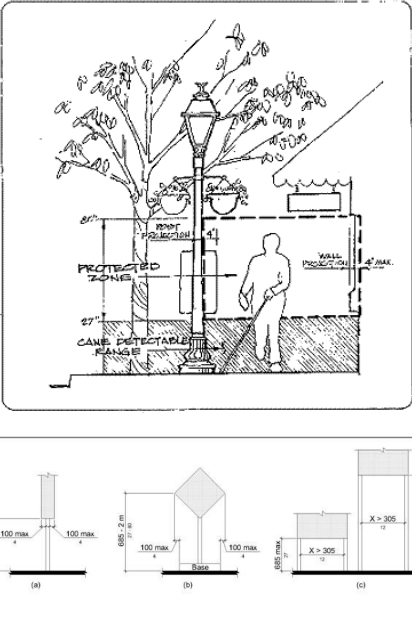
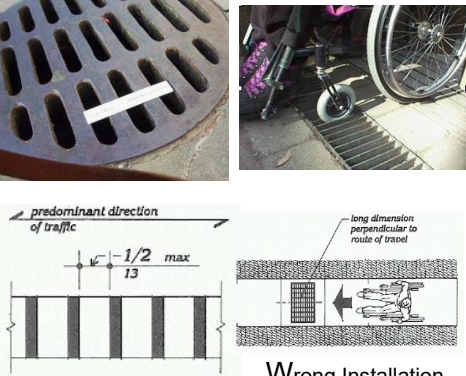
Figures/Examples	Requirements <sup>1</sup>	YES	NO	NA
	<ul style="list-style-type: none"> <li>• Protruding objects on sidewalks and other pedestrian circulation paths shall not reduce the clear width required for pedestrian accessible routes.</li> <li>• Objects with leading edges more than 27 inches and not more than 80 inches above the finish floor or ground shall protrude 4 inches maximum horizontally into the circulation path.</li> <li>• Free-standing objects mounted on posts or pylons shall overhang circulation paths 4 inches maximum measured horizontally from the post or pylon base when located 27 inches minimum and 80 inches maximum above the finish floor or ground. The base dimension shall be 2.5 inches thick minimum. (2011 PROWAG R402.3)</li> <li>• Where a sign or other obstruction is mounted between posts or pylons and the clear distance between the posts or pylons is greater than 12 inches, the lowest edge of such sign or obstruction shall be 27 inches maximum or 80 inches minimum above the finish floor or ground.</li> <li>• Vertical clearance shall be 80 inches high minimum. Guardrails or other barriers shall be provided where the vertical clearance is less than 80 inches high. The leading edge of such guardrail or barrier shall be located 27 inches maximum above the finish floor or ground.</li> <li>• Guardrails or other barriers shall be provided where the vertical clearance is less than 80 inches high. The leading edge of such guardrail or barrier shall be located 27 inches maximum above the finish surface or ground.</li> </ul>			
 <p>Wrong Installation</p>	<ul style="list-style-type: none"> <li>• Openings in floor and ground surfaces shall not allow passage of a sphere more than ½ inch diameter. Elongated openings shall be placed so that the long dimension is perpendicular to the dominant direction of travel.</li> <li>• Gratings, access covers, and other appurtenances shall not be located on curb ramps, landings, blended transitions, and gutters within the pedestrian access route.</li> <li>• Lift holes for manhole/utility covers shall not have an opening greater than ½ inch. Plugging of holes greater than ½ inch with a material approved by the engineer is acceptable as long as it complies with the changes in level requirements.</li> </ul>			

**ENTRANCES (PROWAG R301)**

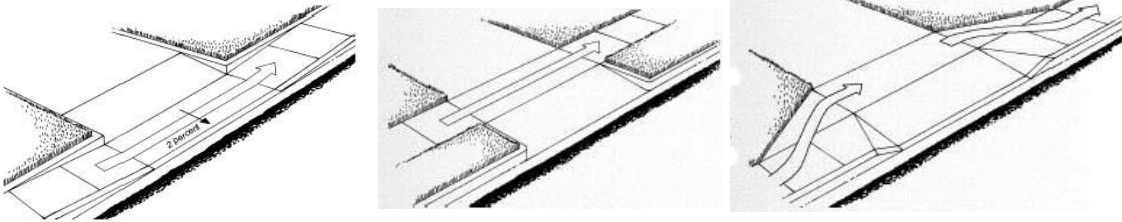
Figures/Examples	Requirements <sup>1</sup>	YES	NO	NA
	<ul style="list-style-type: none"> <li>The minimum continuous and unobstructed clear width of a pedestrian access route provided across commercial and residential entrances shall be 4 feet minimum.</li> <li>Cross slope shall be 2 percent maximum.</li> <li>Be cautious with the transition from the driveway to the roadway to avoid grade combinations that will cause vehicles to bottom out when driving over the transition. <sup>2</sup></li> </ul> 			

**EDGE PROTECTION (PROWAG R406.8)**

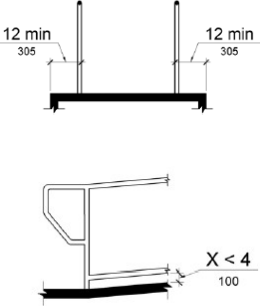
Figures/Examples	Requirements <sup>1</sup>	YES	NO	NA
	<ul style="list-style-type: none"> <li>Edge protection shall be provided on each side of ramp runs and at each side of ramp landings.</li> <li>A curb or barrier shall be provided that prevents the passage of a 4 inch diameter sphere, where any portion of the sphere is within 4 inches of the finish floor or ground surface.</li> <li>Edge-protection shall not be required when the floor or ground surface of the ramp run or landing extends 12 inches minimum beyond the inside face of a handrail.</li> <li>Edge protection shall not be required on curb ramps and their landings.</li> <li>Edge protection shall not be required on ramps that are not required to have handrails and have flares not steeper than 1:10.</li> <li>Edge protection shall not be required on the sides of ramp landings having a vertical drop-off of 1/2 inch maximum within 10 inches horizontally of the minimum landing area.</li> </ul>			

## HANDRAIL AND PEDESTRIAN GUARDRAIL (PROWAG R408)

Figures/Examples	Requirements <sup>1</sup>	YES	NO	NA
	<ul style="list-style-type: none"> <li>The clear width of walking surfaces shall be 4.0 feet minimum.</li> <li>Handrails are required on ramp runs with a rise greater than 6 inches and on certain stairways. Handrails are not required on walking surfaces with running slopes less than 1:20. Where required, handrails shall be provided on both sides of stairs and ramps.</li> <li>Handrails shall be continuous within the full length of each stair flight or ramp run. Inside handrails on switchback or dogleg stairs and ramps shall be continuous between flights or runs.</li> <li>Top of gripping surfaces of handrails shall be 34 inches minimum and 38 inches maximum vertically above walking surfaces, stair nosings, and ramp surfaces. Handrails shall be at a consistent height above walking surfaces, stair nosings, and ramp surfaces.</li> <li>Clearance between handrail gripping surfaces and adjacent surfaces shall be 1 1/2 inches minimum.</li> <li>Handrail gripping surfaces with a circular cross section shall have an outside diameter of 1 1/4 inches minimum and 2 inches maximum.</li> <li>Handrail gripping surfaces with a non-circular cross section shall have a perimeter dimension of 4 inches minimum and 6 1/4 inches maximum, and a cross-section dimension of 2 1/4 inches maximum.</li> <li>Handrail gripping surfaces and any surfaces adjacent to them shall be free of sharp or abrasive elements and shall have rounded edges.</li> <li>Handrails shall not rotate within their fittings.</li> <li>Ramp handrails shall extend horizontally above the landing for 12 inches minimum beyond the top and bottom of ramp runs. Extensions shall return to a wall, guard, or the landing surface, or shall be continuous to the handrail of an adjacent ramp run.</li> <li>At the top of a stair flight, handrails shall extend horizontally above the landing for 12 inches minimum beginning directly above the first riser nosing. Extensions shall return to a wall, guard, or the landing surface, or shall be continuous to the handrail of an adjacent stair flight.</li> <li>At the bottom of a stair flight, handrails shall extend at the slope of the stair flight for a horizontal distance at least equal to one tread depth beyond the last riser nosing. Extension shall return to a wall, guard, or the landing surface, or shall be continuous to the handrail of an adjacent stair flight.</li> <li>See Edge Protection section above (also PROWAG 406.8) for additional details.</li> </ul>			



## STAIRWAYS (PROWAG R407)

Figures/Examples	Requirements <sup>1</sup>	YES	NO	NA
	<ul style="list-style-type: none"> <li>All steps on a flight of stairs shall have uniform riser heights and uniform tread depths. Risers shall be 4 inches high minimum and 7 inches high maximum. Treads shall be 11 inches deep minimum.</li> <li>Open risers are not permitted.</li> <li>The radius of curvature at the leading edge of the tread shall be 1/2 inch maximum. Nosings that project beyond risers shall have the underside of the leading edge curved or beveled. Risers shall be permitted to slope under the tread at an angle of 30 degrees maximum from vertical. The permitted projection of the nosing shall extend 1 1/2 inches maximum over the tread below.</li> <li>Stairs shall have handrails complying with PROWAG 2005 R408.</li> </ul>			

## UNOBSTRUCTED REACH RANGES (PROWAG R406)

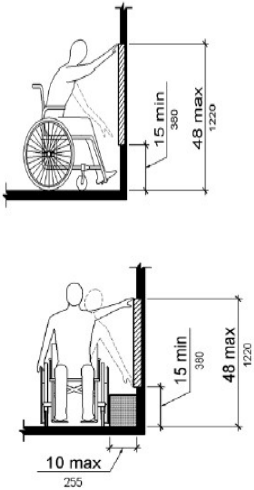
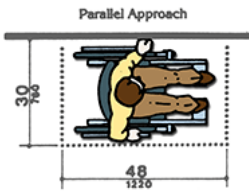
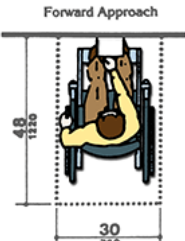
Figures/Examples	Requirements <sup>1</sup>	YES	NO	NA
	<p><b>Forward Reach</b></p> <ul style="list-style-type: none"> <li>Where a forward reach is unobstructed, the high forward reach shall be 48 inches maximum and the low forward reach shall be 15 inches minimum above the finish floor or ground.</li> </ul> <p><b>Side Reach</b></p> <ul style="list-style-type: none"> <li>Where a clear floor or ground space allows a parallel approach to an element and the side reach is unobstructed, the high side reach shall be 48 inches maximum and the low side reach shall be 15 inches minimum above the finish floor or ground.</li> <li><b>EXCEPTION:</b> An obstruction shall be permitted between the clear floor or ground space and the element where the depth of the obstruction is 10 inches maximum. (2011 PROWAG R406.3)</li> </ul> <div style="display: flex; justify-content: space-around; align-items: center;"> <div style="text-align: center;"> <p>Parallel Approach</p>  </div> <div style="text-align: center;"> <p>Forward Approach</p>  </div> </div>			

## CURB RAMPS (PROWAG R304)

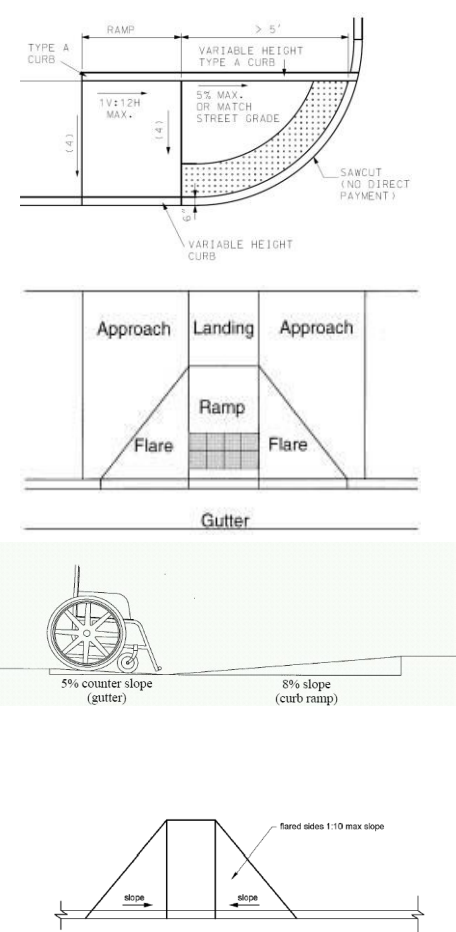
Figures/Examples	Requirements <sup>1</sup>	YES	NO	NA
<p>A curb ramp, blended transition, or a combination of curb ramps and blended transitions shall connect the pedestrian access routes at each pedestrian street crossing.</p>  <p><b>15 Foot Rule:</b> For a compliant curb ramp to exceed 8.33 percent running grade, its constructed length must exceed 15.0 feet.</p>	<ul style="list-style-type: none"> <li>• The clear width of curb ramps, excluding the flares, shall be 4.0 feet minimum.</li> <li>• Curb Ramp runs shall have a running slope between 5 percent minimum and 8.33 percent maximum but shall not require the curb ramp length to exceed 15.0 feet.</li> </ul> <p><b>Exception: 15 Foot Rule:</b> The running slope for a curb ramp is not limited to 8.33 percent maximum if the constructed curb ramp length exceeds 15 feet in length.</p> <ul style="list-style-type: none"> <li>• Cross slope of ramp runs shall be 2 percent maximum. (Roadway Grade Exception may be considered)</li> <li>• The cross slope at midblock crossings shall be permitted to be warped to meet street or highway grade.</li> <li>• Handrails and Edge protection shall not be required on curb ramps and their landings.</li> <li>• Curb height = 0 inches within curb ramp spaces.</li> <li>• Curb ramps must be flush with street.</li> <li>• The counter slope of the gutter or street at the foot of a curb ramp, landing, or blended transition shall be 5 percent maximum. (R303.3.5)</li> <li>• The adjacent surfaces at transitions at curb ramps to walks, gutters, and streets shall be at the same level.</li> <li>• Flared sides with a slope of 10 percent maximum, measured parallel to the curbline, shall be provided where a pedestrian circulation path crosses the curb ramp.             <ul style="list-style-type: none"> <li>- In alterations, where there is no landing at the top of curb ramps, curb ramp flares shall be provided and shall not be steeper than 1:12.</li> </ul> </li> <li>• Detectable warning surfaces shall be provided, where a curb ramp, landing, or blended transition connects to a street.</li> <li>• Gratings, access covers, and other appurtenances shall not be located on curb ramps, landings, blended transitions, and gutters within the pedestrian access route.</li> <li>• Grade breaks shall not be permitted on the surface of curb ramps, blended transitions, landings, and gutter areas within the pedestrian access route. Surface slopes that meet at grade breaks shall be flush.</li> <li>• Grade Breaks at the top and bottom of curb ramp runs shall be perpendicular to the direction of the ramp run.</li> </ul>			

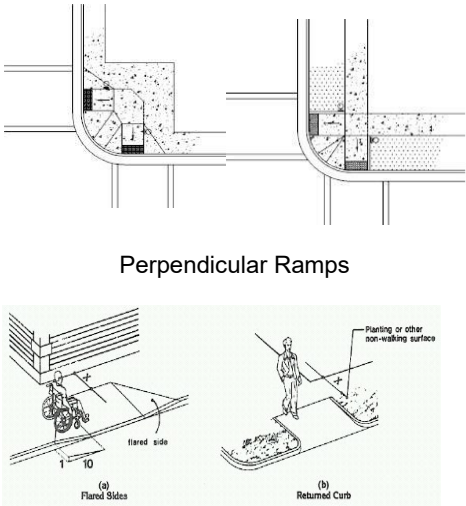
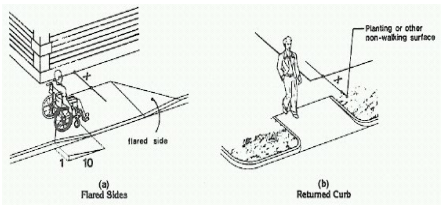
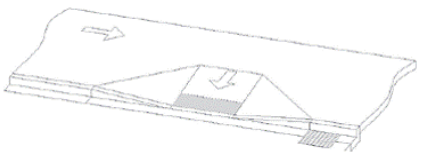

Figures/Examples	Requirements <sup>1</sup>	YES	NO	NA
 <p style="text-align: center;">Perpendicular Ramps</p>  <p style="text-align: center;">X = 4' Min. Flared Sides in Pathway    Flared Sides Not in Pathway</p> <p><b><u>Roadway Grade Exception:</u></b> Where curb ramps, landings and blended transitions are contained within a street or highway right-of-way, the grade of the pedestrian access route is permitted to be modified to equal the general grade established for the adjacent street or highway.</p> 	<ul style="list-style-type: none"> <li>• <b>Perpendicular curb ramps</b> shall have a running slope that cuts through or is built up to the curb at right angles or meets the gutter grade break at right angles.</li> <li>• The clear width of landings, blended transitions, and curb ramps, excluding flares, shall be 4.0 feet minimum.</li> <li>• The running slope shall be 5 percent minimum and 8.33 percent maximum but shall not require the ramp length to exceed 15.0 feet.</li> <li>• The cross slope at intersections shall be 2 percent maximum. (Roadway Grade Exception may be considered)</li> <li>• The cross slope at midblock crossings shall be permitted to be warped to meet street or highway grade.</li> </ul> <p><b><u>Roadway Grade Exception:</u></b> The grade of pedestrian access routes within sidewalks is permitted to equal the general grade established for the adjacent street or highway. The cross slope of curb ramps, blended transitions, landings, and turning spaces at pedestrian street crossings without yield or stop control where vehicles can proceed through the intersection without slowing or stopping, and at midblock pedestrian street crossings are permitted to equal the street or highway grade.</p> <ul style="list-style-type: none"> <li>• A landing 4.0 feet minimum by 4.0 feet minimum shall be provided at the top of the curb ramp and shall be permitted to overlap other landings and clear space.</li> <li>• Flared sides with a slope of 10 percent maximum, measured parallel to the curbline, shall be provided where a pedestrian circulation path crosses the curbramp.</li> <li>• If the flared sides are not in the pathway (grass next to ramp), then there is no maximum slope and can be vertical curbs. (See adjacent figure for further explanation.)</li> <li>• Detectable warning surfaces shall be provided, where a curb ramp, landing, or blended transition connects to a street.</li> <li>• Gratings, access covers, and other appurtenances shall not be located on curb ramps, landings, blended transitions, and gutters within the pedestrian access route.</li> <li>• Grade breaks at the top and bottom of perpendicular curb ramps shall be perpendicular to the direction of ramp run. At least one end of the bottom grade break shall be at the back of curb.</li> <li>• Grade breaks shall not be permitted on the surface of curb ramps, blended transitions, landings, and gutter areas within the pedestrian access route. Surface slopes that meet at grade breaks shall be flush.</li> <li>• Where both ends of the bottom grade break are 5.0 feet or less from the back of curb, the detectable warning shall be located on the ramp surface at the bottom grade break. Where either end of the bottom grade break is more than 5.0 feet from the back of curb, the detectable warning shall be located on the lower landing.</li> </ul>			

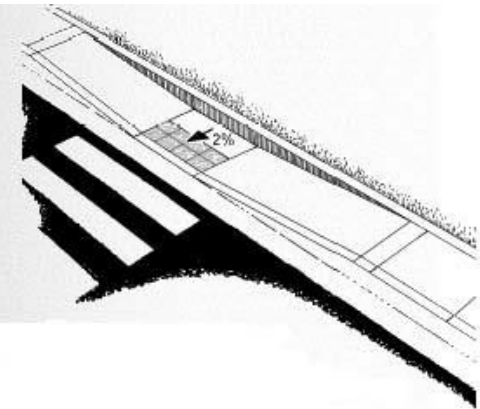
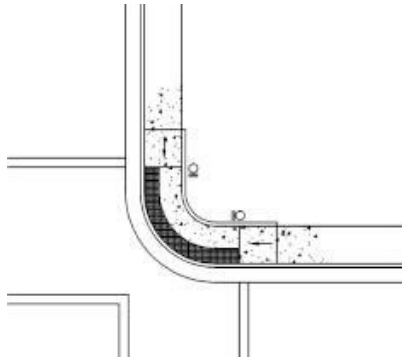
Figures/Examples	Requirements <sup>1</sup>	YES	NO	NA
 <p data-bbox="86 625 562 803">Curb Ramps and landings that are contained within a street or highway border may use the Roadway Grade Exception for slopes or cross slopes in the direction of the roadway travel being matched.</p>	<ul style="list-style-type: none"> <li>• <b>Parallel curb ramps</b> shall have a running slope that is in-line with the direction of sidewalk travel.</li> <li>• The clear width of landings, blended transitions, and curb ramps, excluding flares, shall be 4.0 feet minimum.</li> <li>• The running slope shall be 5 percent minimum and 8.33 percent maximum but shall not require the ramp length to exceed 15.0 feet.</li> <li>• The cross slope shall be 2 percent maximum. (Roadway Grade Exception may be considered)</li> </ul> <p><b><u>Roadway Grade Exception:</u></b> The grade of pedestrian access routes within sidewalks is permitted to equal the general grade established for the adjacent street or highway. The cross slope of curb ramps, blended transitions, landings, and turning spaces at pedestrian street crossings without yield or stop control where vehicles can proceed through the intersection without slowing or stopping, and at midblock pedestrian street crossings are permitted to equal the street or highway grade.</p> <ul style="list-style-type: none"> <li>• A landing 4.0 feet minimum by 4.0 feet minimum shall be provided at the bottom of the ramp run and shall be permitted to overlap other landings and clear floor or ground space.</li> <li>• Where a parallel curb ramp does not occupy the entire width of a sidewalk, drop-offs at diverging segments shall be protected.</li> <li>• Detectable warning surfaces shall be provided, where a curb ramp, landing, or blended transition connects to a street.</li> <li>• Gratings, access covers, and other appurtenances shall not be located on curb ramps, landings, blended transitions, and gutters within the pedestrian access route.</li> <li>• Grade breaks shall not be permitted on the surface of curb ramps, blended transitions, landings, and gutter areas within the pedestrian access route. Surface slopes that meet at grade breaks shall be flush.</li> </ul>			
	<ul style="list-style-type: none"> <li>• <b>Blended Transitions</b> shall have a running slope of 5 percent maximum and cross slope shall be 2 percent maximum.</li> <li>• The clear width blended transitions, excluding flares, shall be 4.0 feet minimum.</li> <li>• Detectable warning surfaces shall be provided where a blended transition connects to a street.</li> <li>• Gratings, access covers, and other appurtenances shall not be located on blended transitions within the pedestrian access route.</li> <li>• Grade breaks at the top and bottom of perpendicular curb ramps shall be perpendicular to the direction of ramp run. At least one end of the bottom grade break shall be at the back of curb. Grade breaks shall not be permitted on the surface of blended transitions and gutter areas within the pedestrian access route. Surface slopes that meet at grade breaks shall be flush.</li> </ul>			

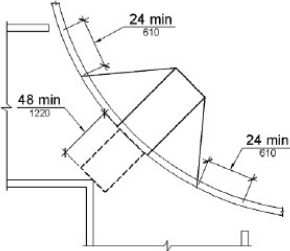
Figures/Examples	Requirements <sup>1</sup>	YES	NO	NA
 	<ul style="list-style-type: none"> <li>• <b>Diagonal Curb Ramps or corner type curb ramps are no longer preferred design types. A design that provides individual ramps for each crossing direction is recommended by the US Access Board.</b></li> <li>• Diagonal Curb Ramps or corner type curb ramps with returned curbs or other well-defined edges shall have the edges parallel to the direction of pedestrian flow.</li> <li>• The bottom of diagonal curb ramps shall have a clear space 48 inches minimum outside active traffic lanes of the roadway.</li> <li>• Diagonal curb ramps provided at marked crossings shall provide the 48 inches minimum clear space within the markings.</li> <li>• Diagonal curb ramps with flared sides shall have a segment of curb 24 inches long minimum located on each side of the curb ramp and within the marked crossing.</li> </ul> <p><b><u>Roadway Grade Exception:</u></b> The grade of pedestrian access routes within sidewalks is permitted to equal the general grade established for the adjacent street or highway. The cross slope of curb ramps, blended transitions, landings, and turning spaces at pedestrian street crossings without yield or stop control where vehicles can proceed through the intersection without slowing or stopping, and at midblock pedestrian street crossings are permitted to equal the street or highway grade.</p> <ul style="list-style-type: none"> <li>• Detectable warning surfaces shall be provided, where a curb ramp, landing, or blended transition connects to a street.</li> <li>• Gratings, access covers, and other appurtenances shall not be located on curb ramps, landings, blended transitions, and gutters within the pedestrian access route.</li> <li>• Grade breaks shall not be permitted on the surface of curb ramps, blended transitions, landings, and gutter areas within the pedestrian access route. Surface slopes that meet at grade breaks shall be flush.</li> <li>• Running and cross slope at midblock crossings shall be permitted to be warped to meet street or highway grade.</li> </ul>			



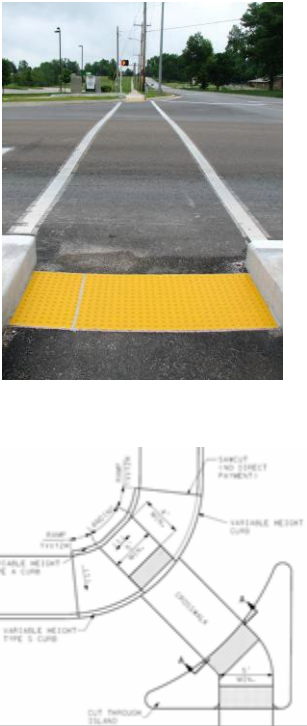

**DETECTABLE WARNINGS DEVICES (TRUNCATED DOMES) (PROWAG R304)**

Figures/Examples	Requirements <sup>1</sup>	YES	NO	NA
<p>A surface feature of truncated dome material built in or applied to the walking surface to advise of an upcoming change from pedestrian to vehicular way.</p>	<ul style="list-style-type: none"> <li>• Detectable warnings shall consist of a surface of truncated domes aligned in a square or radial grid pattern complying with 2010 ADA Standards. Detectable warning surfaces shall contrast visually with adjacent gutter, street or highway, or walkway surfaces, either light-on-dark or dark-on-light.</li> <li>• Detectable warning surfaces shall extend 24 inches minimum in the direction of travel and the full width of the curb ramp (exclusive of flares), the landing, or the blended transition. Detectable warning surfaces are required where curb ramps, blended transitions, or landings provide a flush pedestrian connection to the street.</li> <li>• Sidewalk crossings of residential driveways should not generally be provided with detectable warnings, since the pedestrian right-of-way continues across most driveway aprons and overuse of detectable warning surfaces should be avoided in the interests of message clarity. However, where commercial driveways are provided with traffic control devices or otherwise are permitted to operate like public streets, detectable warnings should be provided at the junction between the pedestrian route and the street.</li> <li>• Perpendicular Curb Ramps: Where both ends of the bottom grade break are 5 feet or less from the back of curb, the detectable warning shall be located on the ramp surface at the bottom grade break. Where either end of the bottom grade break is more than 5 feet from the back of curb, the detectable warning shall be located on the lower landing.</li> <li>• Landings and Blended Transitions: The detectable warning shall be located on the landing or blended transition at the back of curb.</li> <li>• Rail Crossings: The detectable warning surface shall be located so that the edge nearest the rail crossing is 6 feet minimum and 15 feet maximum from the centerline of the nearest rail. The rows of truncated domes in a detectable warning surface shall be aligned to be parallel with the direction of wheelchair travel.</li> <li>• Detectable warnings at cut-through islands shall be located at the curb line in-line with the face of curb and shall be separated by a 2.0 foot minimum length of walkway without detectable warnings. Where the island has no curb, the detectable warning shall be located at the edge of roadway.</li> <li>• Exception, when detectable warnings are required by a manufacturer's installation specifications to be embedded into concrete with a surrounding edge, domes may be installed at less than the required full width. Under this exception, the detectable warning surface shall never be more than 2 inches from the edge of the curb ramp, the landing, or the blended transition. <sup>2</sup></li> <li>• Detectable warnings shall not be stamped into concrete.</li> </ul>			

### ISLANDS AND MEDIANS (PROWAG R305.4)



Figures/Examples	Requirements <sup>1</sup>	YES	NO	NA
	<ul style="list-style-type: none"> <li>• Medians and pedestrian refuge islands in crosswalks shall contain a pedestrian access route, including passing space and connecting to each crosswalk.</li> <li>• Raised islands in crossings shall be cut through level with the street or have curb ramps and required landings at both sides.</li> <li>• All median island passage spaces shall provide a clear width of 5 feet minimum. <sup>2</sup></li> <li>• Medians and pedestrian refuge islands shall be 6.0 feet minimum in length in the direction of pedestrian travel.</li> </ul> <p><b><u>Roadway Grade Exception:</u></b> The grade of pedestrian access routes within sidewalks is permitted to equal the general grade established for the adjacent street or highway. The cross slope of curb ramps, blended transitions, landings, and turning spaces at pedestrian street crossings without yield or stop control where vehicles can proceed through the intersection without slowing or stopping, and at midblock pedestrian street crossings are permitted to equal the street or highway grade.</p> <ul style="list-style-type: none"> <li>• Each curb ramp shall have a level area 48 inches long minimum by 48 inches wide minimum at the top of the curb ramp in the part of the island intersected by the crossings.</li> <li>• The 48 inch minimum by 48 inch minimum areas and the accessible route shall be permitted to overlap.</li> <li>• Detectable warning surfaces shall be provided, where a curb ramp, landing, or blended transition connects to a street. Medians and pedestrian refuge islands shall have detectable warnings at curb ramps and blended transitions.</li> <li>• Detectable warnings at cut-through islands shall be located at the curb line in-line with the face of curb and shall be separated by a 2.0 foot minimum length of walkway without detectable warnings. Where the island has no curb, the detectable warning shall be located at the edge of roadway.</li> <li>• Gratings, access covers, and other appurtenances shall not be located on curb ramps, landings, blended transitions, and gutters within the pedestrian access route.</li> <li>• Grade breaks shall not be permitted on the surface of curb ramps, blended transitions, landings, and gutter areas within the pedestrian access route. Surface slopes that meet at grade breaks shall be flush.</li> </ul>			

**ACCESSIBLE PEDESTRIAN SIGNALS (PUSHBUTTONS) (PROWAG R306 and EPG 902.6.1 – EPG 902.6.15)**

Figures/Examples	Requirements <sup>1</sup>	YES	NO	NA
    	<ul style="list-style-type: none"> <li>• Each crosswalk with pedestrian signal indication shall have an accessible pedestrian signal which includes audible and vibrotactile indications of the WALK interval at new signalized intersections and shall be considered at existing intersections being altered or are needing maintenance applications. Where a pedestrian pushbutton is provided, it shall be integrated into the accessible pedestrian signal.</li> <li>• Accessible pedestrian signals shall be located so that the vibrotactile feature can be contacted from the level landing serving a curb ramp, if provided, or from a clear floor or ground space that is in line with the crosswalk line adjacent to the vehicle stop line.</li> <li>• Accessible pedestrian pushbuttons shall be located within a reach range complying with EPG 642.</li> <li>• A clear floor or ground space shall be provided at the pushbutton and shall connect to or overlap the pedestrian access route.</li> </ul> <p><b>Roadway Grade Exception:</b> Clear spaces required at accessible pedestrian signals and pedestrian pushbuttons and at other accessible elements are permitted to have a running slope or cross slope consistent with the grade of the adjacent pedestrian access route.</p> <ul style="list-style-type: none"> <li>• Pedestrian signals shall comply with PROWAG 2005 R306 and EPG 902.6.1 through 902.6.15.             <ul style="list-style-type: none"> <li>- Pushbuttons are a minimum 2 inches across in one dimension, raised (not recessed), contrast visually with the housing or mounting, and have a maximum force of 3.5 pounds to activate operable parts.</li> <li>- The control face of the pushbuttons is installed parallel to the direction of the crosswalk it serves.</li> <li>- The location of pushbuttons for new construction are within a longitudinal distance of 5 feet maximum from the crosswalk line, and 30 inches minimum to 6 feet maximum from the curb line.</li> <li>- For audible pedestrian signal devices only, pushbuttons are a minimum 10 feet apart.</li> <li>- Pushbuttons are located at a height of approximately 42 inches, but no higher than 48 inches from the ground and within 10 inch reach from a level paved clear floor or ground space with minimum dimensions of 48 inches x 30 inches positioned for a parallel approach to the pushbutton. For a forward approach space (30 x 48 inches) the allowed reach range is 0 inches.</li> <li>- Where pushbuttons for the visually impaired are installed, tactile signs are to be provided that meet ADA requirements.</li> </ul> </li> </ul>			

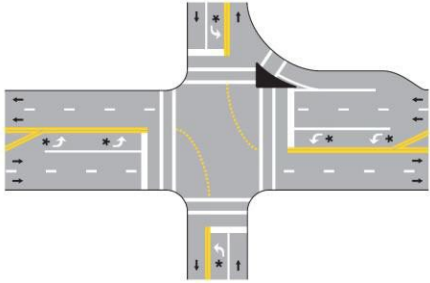

**PEDESTRIAN STREET CROSSINGS (PROWAG R305 and EPG 642)**

Figures/Examples	Requirements <sup>1</sup>	YES	NO	NA
 	<ul style="list-style-type: none"> <li>• Crosswalks shall contain a pedestrian access route that connects to departure and arrival walkways through any median or pedestrian refuge island.</li> <li>• Marked crosswalks shall be 6 feet wide minimum.</li> <li>• The grade of the pedestrian access route is permitted to equal the general grade established for the adjacent street or highway, except that where pedestrian access routes are contained within pedestrian street crossings a maximum grade of 5 percent is required.</li> <li>• A 5 percent maximum cross slope is specified for pedestrian access routes contained within pedestrian street crossings without yield or stop control.</li> <li>• Crossings with Stop Control: The cross slope shall be 2 percent maximum.</li> <li>• The cross slope at midblock crossings shall be permitted to be warped to meet street or highway grade.</li> <li>• The running slope shall be 5 percent maximum, measured parallel to the direction of pedestrian travel in the crosswalk.</li> <li>• Accessible pedestrian signals and pedestrian pushbuttons provided at pedestrian crossings with pedestrian signals (See EPG 642 for applicability) shall comply with EPG 902.6.8 through 902.6.15. Operable parts shall comply with EPG 902.6.9 – 902.6.15.</li> <li>• Crosswalk pavement marking is 6 inches wide white.</li> <li>• Stop bar is at minimum 4 feet from the crosswalk.</li> <li>• Curb ramps at marked crossings shall be wholly contained within the markings, excluding any flared sides.</li> <li>• Gratings, access covers, and other appurtenances shall not be located on curb ramps, landings, blended transitions, and gutters within the pedestrian access route.</li> <li>• Grade breaks shall not be permitted on the surface of curb ramps, blended transitions, landings, and gutter areas within the pedestrian access route. Surface slopes that meet at grade breaks shall be flush.</li> <li>• Beyond the curb face, a clear space of 4.0 feet minimum by 4.0 feet minimum shall be provided within the width of the crosswalk and wholly outside the parallel vehicle travel lane.</li> </ul>			

**ALTERNATE CIRCULATION PATH (PROWAG R302)**

Figures/Examples	Requirements <sup>1</sup>	YES	NO	NA
	<ul style="list-style-type: none"> <li>• Alternate circulation paths shall contain a pedestrian access route.</li> <li>• To the maximum extent feasible, the alternate circulation path shall be provided on the same side of the street as the disrupted route.</li> <li>• Where the alternate circulation path is exposed to adjacent construction, excavation drop-offs, traffic, or other hazards, it shall be protected with a pedestrian barricade or channelizing device complying with MUTCD 6F-58, 6F-63, and 6F-66.</li> <li>• Pedestrian barricades and channelizing devices shall be continuous, stable, and non-flexible and shall consist of a wall, fence, or enclosures specified in section 6F-58, 6F-63, and 6F-66 of the MUTCD (incorporated by reference; see PROWAG 2005 R104.2.4).</li> <li>• A detectable continuous bottom edge shall be provided 2 inches maximum above the ground or walkway surface.</li> <li>• Devices shall provide a continuous surface or upper rail at 3.0 feet minimum above the ground or walkway surface.</li> <li>• Support members shall not protrude into the alternate circulation path.</li> </ul>			

**BUS BOARDING AND ALIGHTING AREAS (PROWAG R410)**

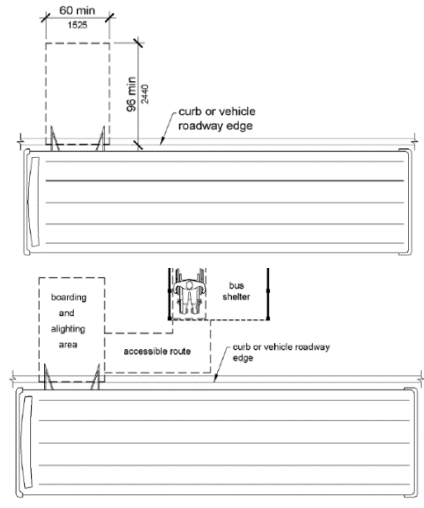
Figures/Examples	Requirements <sup>1</sup>	YES	NO	NA
	<ul style="list-style-type: none"> <li>• Bus stop boarding and alighting areas shall have a firm, stable surface.</li> <li>• Bus stop boarding and alighting areas shall provide a clear length of 8 feet minimum, measured perpendicular to the curb or vehicle roadway edge, and a clear width of 5 feet minimum, measured parallel to the vehicle roadway.</li> <li>• Bus stop boarding and alighting areas shall be connected to streets, sidewalks, or pedestrian paths by an accessible route.</li> <li>• Parallel to the roadway, the slope of the bus stop boarding and alighting area shall be the same as the roadway, to the maximum extent practicable. Perpendicular to the roadway, the slope of the bus stop boarding and alighting area shall not be steeper than 2 percent.</li> <li>• Bus shelters shall provide a minimum 30 inch by 48 inch clear floor or ground space entirely within the shelter.</li> <li>• Bus shelters shall be connected by an accessible route to a boarding and alighting area.</li> </ul>			

<sup>1</sup> Any “NO” answer means that location is ADA non-compliant and needs to be corrected before final acceptance of the work, except as follows. Although exceptions listed in the above requirements may not meet MoDOT current policy standards, work that does meet the minimum ADA standards will be accepted as ADA compliant. Where it is technically infeasible to correct deficiencies as part of the current work, those locations will be labeled as non-compliant and marked “NO”. These items will be added to the Transition Plan Inventory for correction at a later date. (Guidance is provided in ADA documents and in the EPG on what may be considered as technically infeasible.)

<sup>2</sup> A MoDOT requirement.

**Unless otherwise noted, all notes on this form are direct ADA requirements as published in either the PROWAG dated November 23, 2005 or ADA/ABA Standards from 2010.**

All exceptions and technically infeasible locations should be discussed with the project manager and/or area engineer prior to acceptance of the work. All exceptions and technically infeasible locations will need to be thoroughly documented by the engineer, and that documentation will be attached to this form and retained as part of the final acceptance records.

All slope and grade measurements for ADA compliance will be made using a calibrated 2 foot long digital level.

**US Access Board PROWAG**

**R202.3.1 Prohibited Reduction in Required Access.** An alteration shall not decrease or have the effect of decreasing the accessibility of a facility or an accessible connection to an adjacent building or site below the requirements for new construction in effect at the time of the alteration.

<b>Inspector Name:</b> _____ <b>Inspector Signature:</b> _____	<b>Date:</b>
<b>Contractor Representative Name:</b> _____ <b>Contractor Representative Signature:</b> _____	<b>Date:</b>
<b>Resident Engineer or Area Engineer Name:</b> _____ <b>Resident Engineer or Area Engineer Signature:</b>	<b>Date:</b>
<b>Distribution:</b> <input type="checkbox"/> <b>Project Office</b> <input type="checkbox"/> <b>District Permit Office</b>	

# **SAMPLE**

## **ADA EXCEPTIONS DOCUMENTATION**

Job No. \_\_\_\_\_ Route \_\_\_\_\_ County \_\_\_\_\_ Location \_\_\_\_\_

<b><u>Item</u></b>	<b><u>Location</u></b>	<b><u>Standard</u></b>	<b><u>As Built</u></b>	<b><u>Discussion</u></b>
Sidewalk Width	Third Street Sta 3+00 to 7+00 RT	5' wide	Exist 3' wide	Required 5' x 5' Passing Space added at 5+00
Curb Ramp Grade	SE Quad of Main & First	8.33%	11.2%	As-built Curb Ramp is 16.0' long
Parallel Ramp Landing running grade (turning space)	Sta 35+20 to 35+25 Rt Rte 14	2.00%	2.6%	Landing running grade matches existing roadway grade
Sidewalk Grade	Sta 23+45 to 23+52	5.0%	8.4%	Match existing floor at two exist doorways, Straight grade between fixed elevations

Inspector Name: _____	
Inspector Signature: _____	Date:
Resident Engineer or Area Engineer Name: _____	
Resident Engineer or Area Engineer Signature: _____	Date:
<b>Distribution:</b> <input type="checkbox"/> Project Office <input type="checkbox"/> District Permit Office	